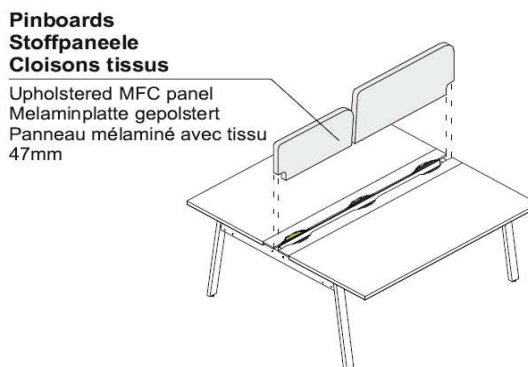
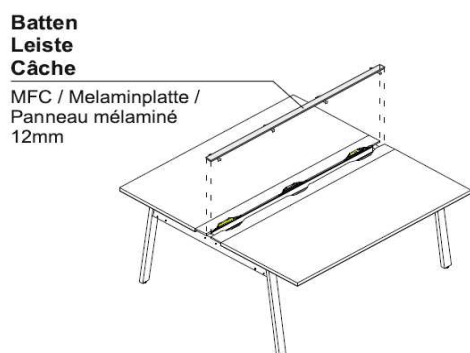
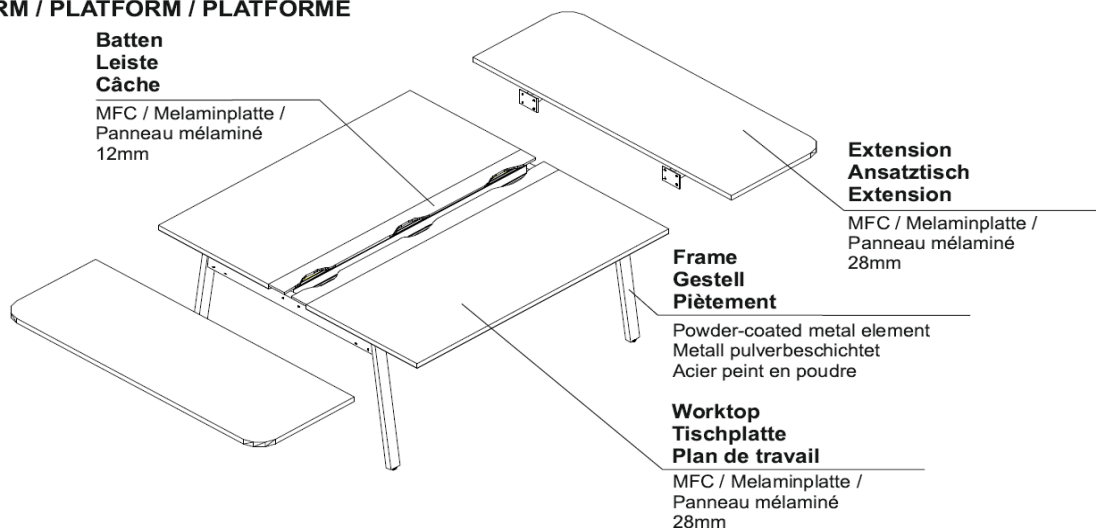
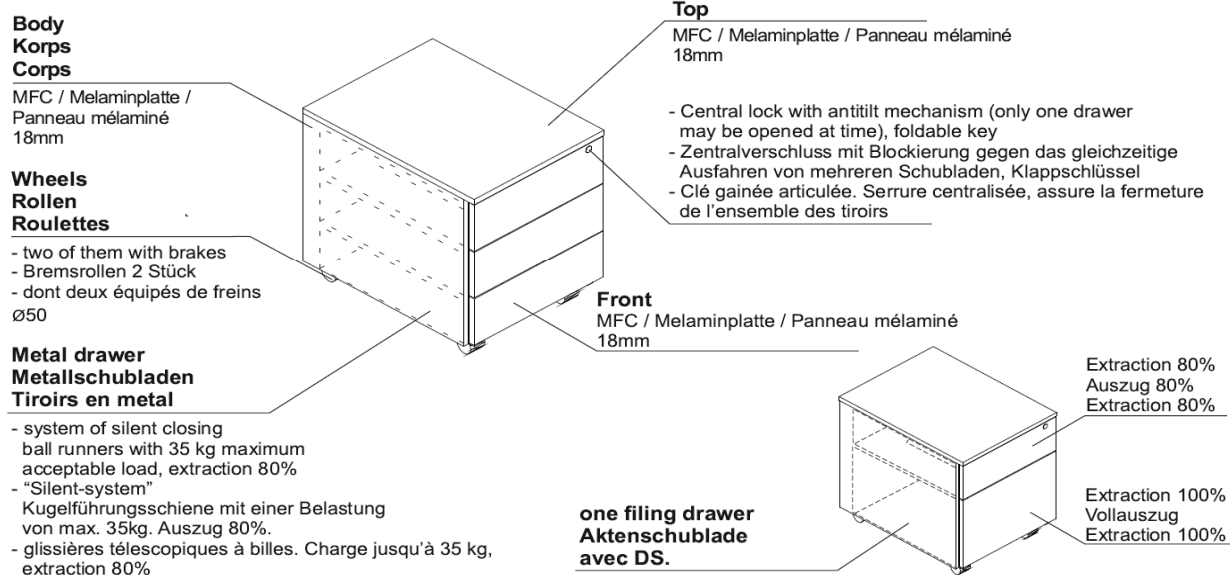


TECHNICAL SPECIFICATION / TECHNISCHE BESCHREIBUNG / DESCRIPTION TECHNIQUE

PLATFORM / PLATFORM / PLATFORME

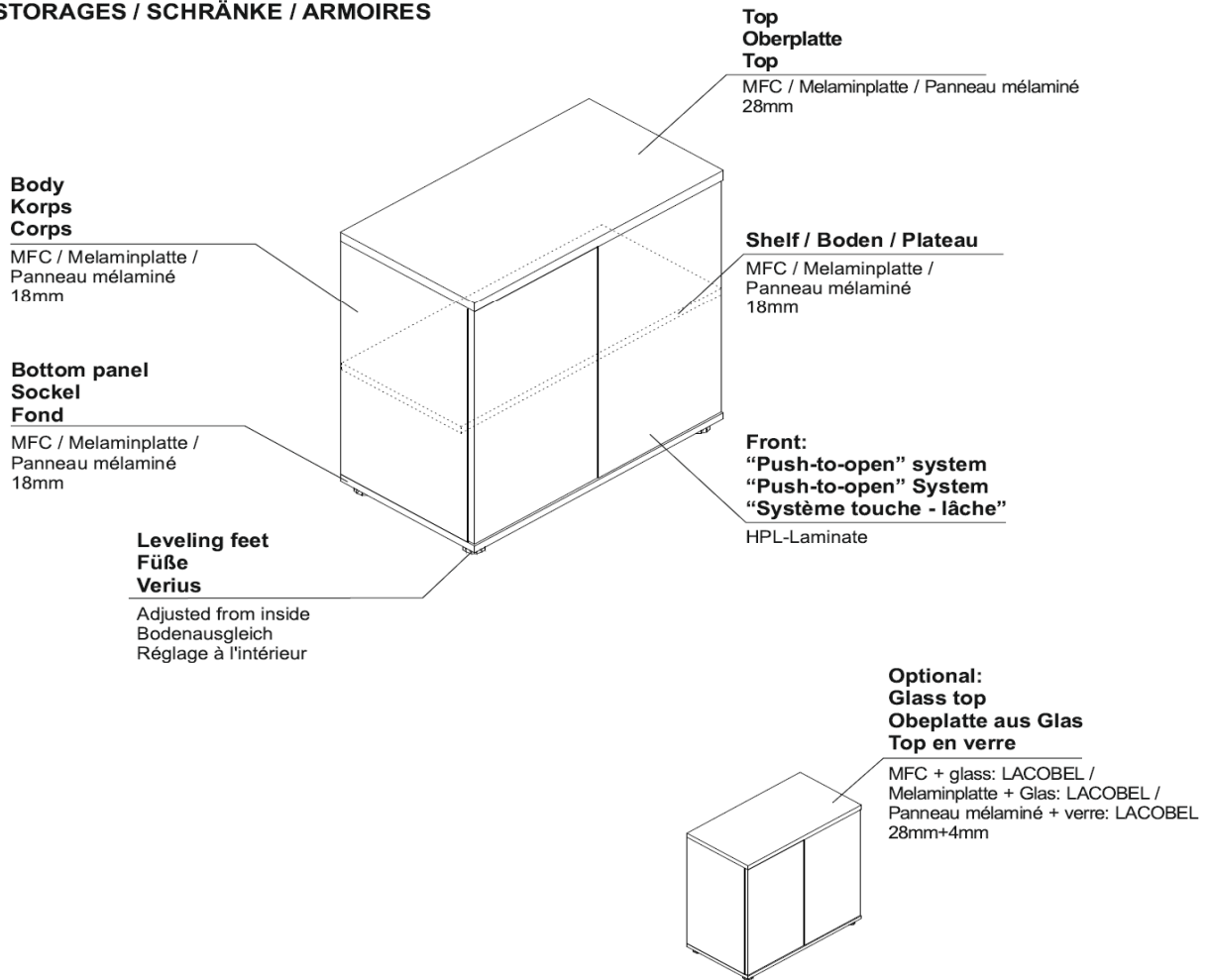


PEDESTAL / CONTAINER / CAISSON

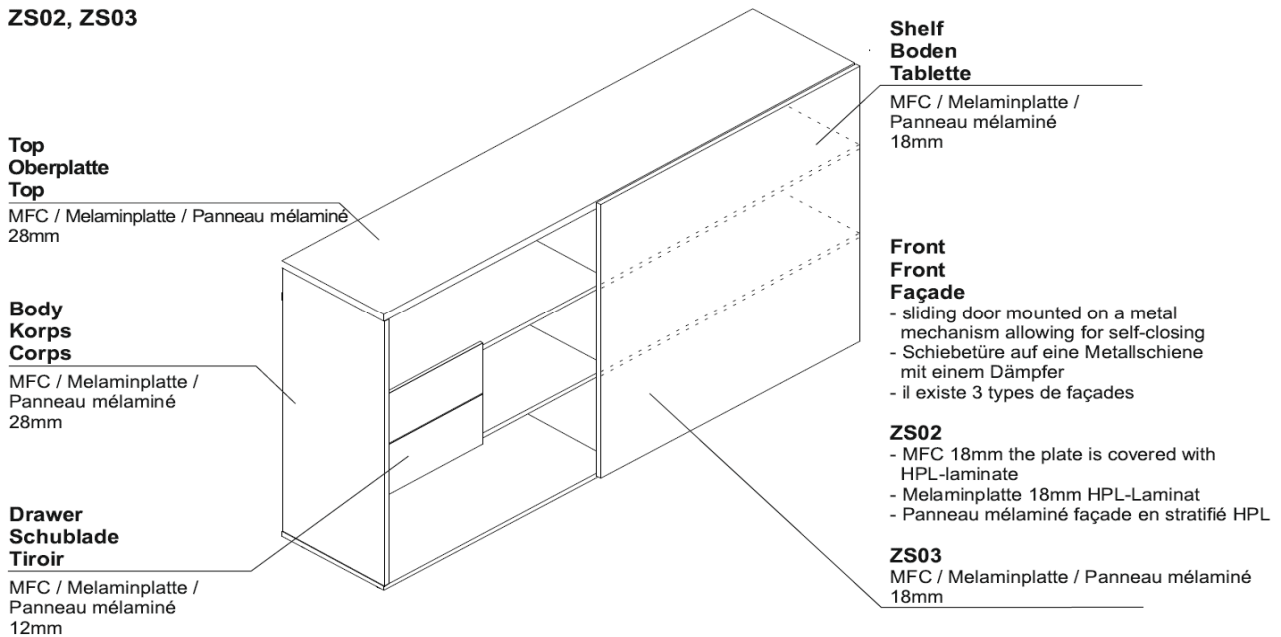


TECHNICAL SPECIFICATION / TECHNISCHE BESCHREIBUNG / DESCRIPTION TECHNIQUE

STORAGES / SCHRÄNKE / ARMOIRES



ZS02, ZS03



FINISHES / FARBEN / FINITIONS

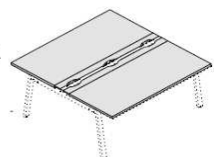


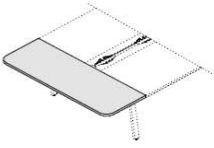


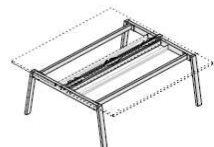


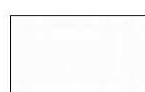

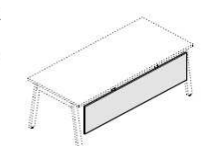

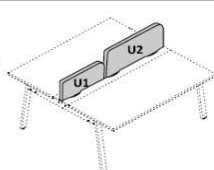
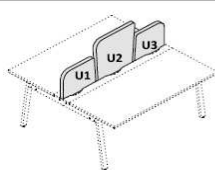
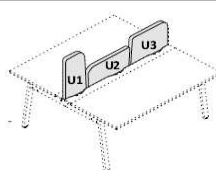
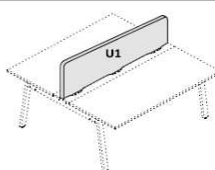






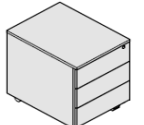
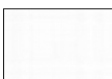
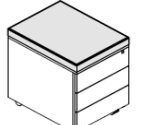

<p>TOP TISCHPLATTE PLAN DE TRAVAIL</p> 	 <p>67 – WHITE PASTEL WEIß PASTELL BLANC PASTEL</p>  <p>31 – CANADIAN OAK KANADISCHE EICHE CHENE CANADIAN</p>
<p>EXTENSION ANSATZTISCH EXTENSION</p> 	 <p>67 – WHITE PASTEL WEIß PASTELL BLANC PASTEL</p>  <p>31 – CANADIAN OAK KANADISCHE EICHE CHENE CANADIAN</p>
<p>FRAME GESTELL PIETEMET</p> 	 <p>15 – WHITE WEIß BLANC</p>
<p>BATTEN LEISTE CACHE</p> 	 <p>67 – WHITE PASTEL WEIß PASTELL BLANC PASTEL</p>  <p>31 – CANADIAN OAK KANADISCHE EICHE CHENE CANADIAN</p>
<p>MODESTY PANEL KNEIBLENDE VOILES DE FOND</p> 	 <p>67 – WHITE PASTEL WEIß PASTELL BLANC PASTEL</p>
<p>PINBOARDS STOFFPANELEE CLOISONS TISSUS</p> 	  
<p>U1 U2 U3</p>	 <p>NX2 – BEIGE BEIGE BEIGE</p>  <p>NX3 – ORANGE ORANGE ORANGE</p>  <p>NX5 – RED ROT ROUGE</p>  <p>NX9 – GREEN GRÜN VERT</p>  <p>NX10 – GRAY GRAU GRIS</p>  <p>NX15 – NAVY BLUE DUNKELBLAU BLEU MARIN</p>

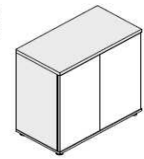
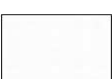





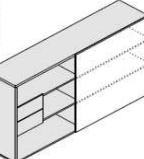


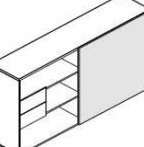




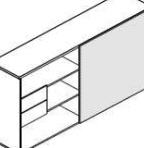
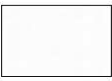



TABLE / TISCH / TABLE BASSE


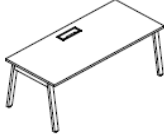

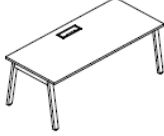
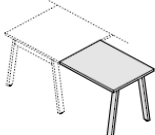
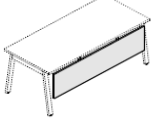
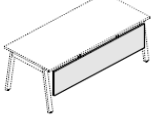

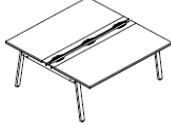
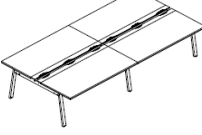

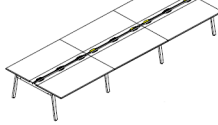
<p>TOP TISCHPLATTE PLAN</p> 	 <p>67 – WHITE PASTEL WEIß PASTELL BLANC PASTEL</p>  <p>31 – CANADIAN OAK KANADISCHE EICHE CHENE CANADIAN</p>
<p>FRAME GESTELL PIETEMET</p> 	 <p>15 – WHITE WEIß BLANC</p>

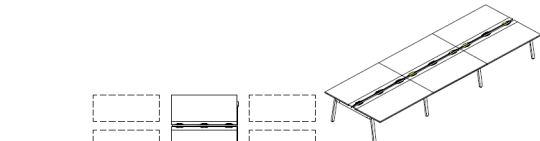
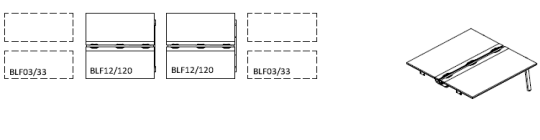
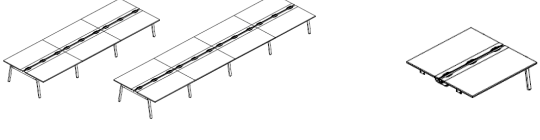


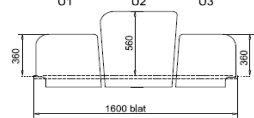

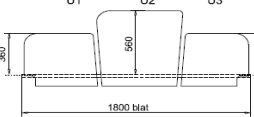

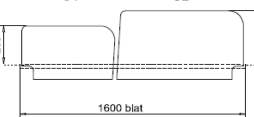

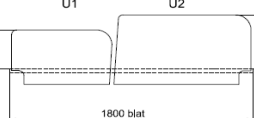
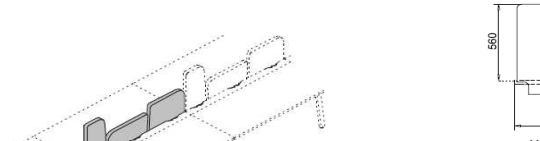
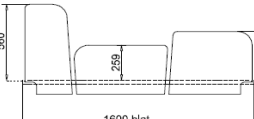

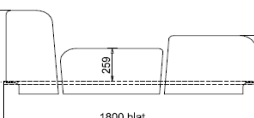
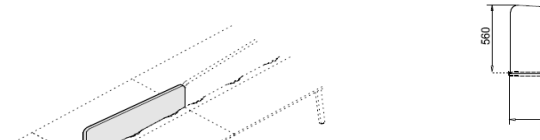
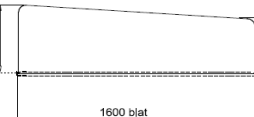

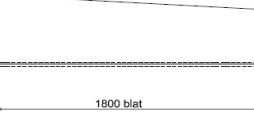
FINISHES / FARBEN / FINITIONS - SLK12, SLK13

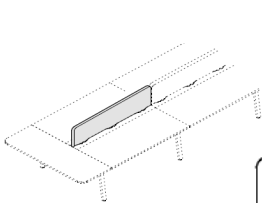
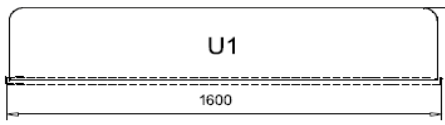
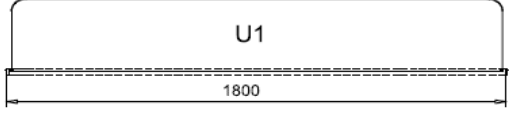
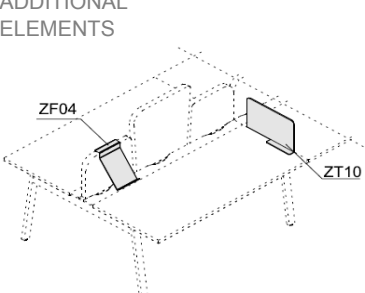
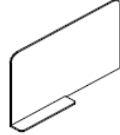
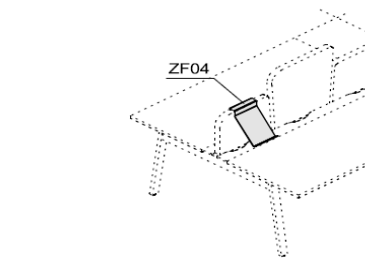

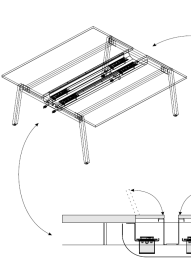
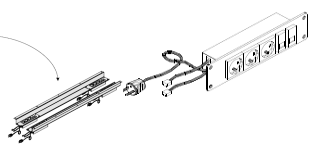

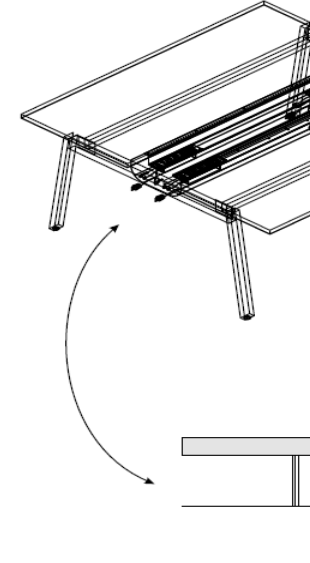
PEDESTAL CONTAINER CAISSON		 67 – WHITE PASTEL WEIß PASTELL BLANC PASTEL
PILLOW SKP13 KISSEN SKP13 PANNEAU TISSU SKP13		 NX10 – GRAY GRAU GRIS

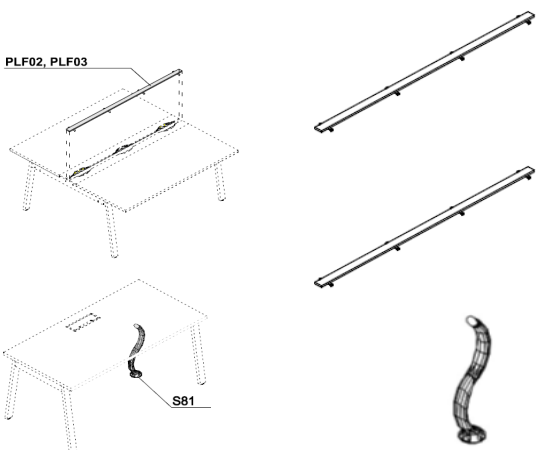

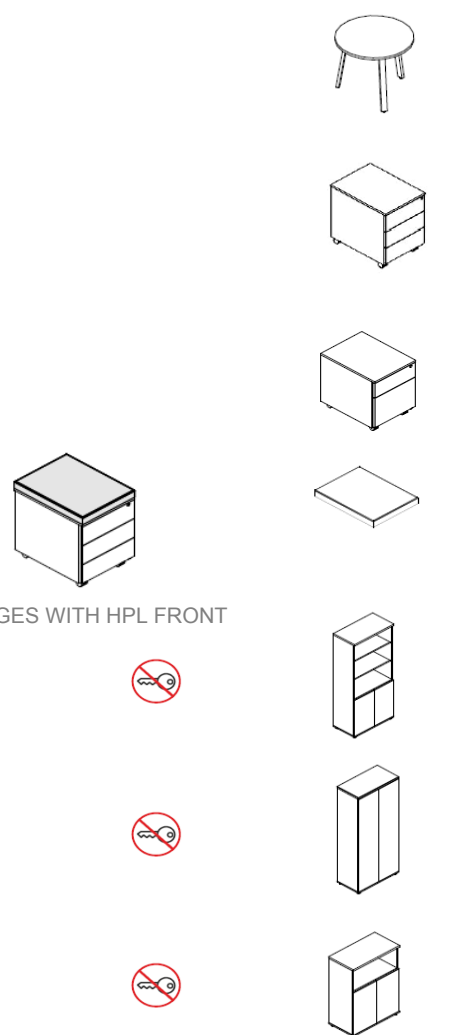
FINISHES / FARBEN / FINITIONS – STORAGES / SCHRÄNKE / RANGEMENTS


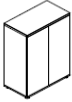




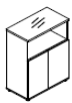



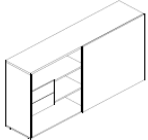
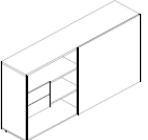


COUNTER TOP AND BODY OBERPLATTE UND KORPS TOP ET CORPS		 67 – WHITE PASTEL WEIß PASTELL BLANC PASTEL			
FRONT HPL HPL - FRONT FRONT STRATIFIE		 72 – HIGH GLOSS LIME GRÜN GLANZ VERT BRILLANT	 73 – HIGH GLOSS WHITE WEIß GLANZ BLANC BRILLANT	 74 – HIGH GLOSS ORANGE ORANGE GLANZ ORANGE BRILLANT	 82 – HIGH GLOSS RED ROTGLANZ ROUGE BRILLANT
COUNTER TOP AND BODY OBERPLATTE UND KORPS TOP ET CORPS		 67 – WHITE PASTEL WEIß PASTELL BLANC PASTEL	 26 – ALUMINIUM SATINATO ALUMINIUM SATINATO ALUMINIUM SATINE		
FRONT HPL - ZS02 FRONT HPL - ZS02 FRONT STRATIFIE - ZS02		 72 – HIGH GLOSS LIME GRÜN GLANZ VERT BRILLANT	 73 – HIGH GLOSS WHITE WEIß GLANZ BLANC BRILLANT	 74 – HIGH GLOSS ORANGE ORANGE GLANZ ORANGE BRILLANT	 82 – HIGH GLOSS RED ROTGLANZ ROUGE BRILLANT
FRONT - ZS03 FRONT - ZS03 FRONT - ZS03		 67 – WHITE PASTEL WEIß PASTELL BLANC PASTEL	 31 – CANADIAN OAK KANADISCHE EICHE CHENE CANADIAN		
DRAWER FOR ZS02, ZS03 SCHUBLADEN ZUM ZS02, ZS03 TIROIR POUR ZS02, ZS03		 67 – WHITE PASTEL WEIß PASTELL BLANC PASTEL			

CITY	DIMENSIONS (mm) width x depth x height a / a' b / b' c / c'	SYMBOL price	SYMBOL price	SYMBOL price	NOTES
DESK 	1600x800x740	BLF16			
	1600x800x740	BLF16M			Mediabox 2 x RJ45/ 4 x 230V
	1800x800x740	BLF18			
	1800x800x740	BLF18M			Mediabox 2 x RJ45/ 4 x 230V
EXTENSION 	800x600x740	PLF04			extension with legs for BLF16,18
MODESTY PANEL 	1400x18x400	UH4			for BLF16, BLF16M
	1600x18x400	UH5			for BLF18, BLF18M
PLATFORM 	1600x1640x740	BLF01			two-user bench
	1800x1640x740	BLF11			two-user bench
	3200x1640x740	BLF02			four-user bench
	3600x1640x740	BLF22			four-user bench
	4800x1640x740	BLF03			six-user bench

CITY	DIMENSIONS (mm) width x depth x height a / a' b / b' c / c'	SYMBOL price	SYMBOL price	SYMBOL price	NOTES
	5400x1640x740	BLF33			six-user bench
	1600x1640x740	BLF12			platform elements
	1800x1640x740	BLF120			platform elements
<p>EXTENSION</p> 	1640x600x28	PLF01			extension with mounting elements
<p>PINBOARDS</p> 		ZT01			given height over the desktop
		ZT11			given height over the desktop
		ZT02			given height over the desktop
		ZT12			given height over the desktop
		ZT03			given height over the desktop
		ZT13			given height over the desktop
		ZT16			given height over the desktop
		ZT18			given height over the desktop

CITY	DIMENSIONS (mm) width x depth x height a / a' b / b' c / c'			SYMBOL price	SYMBOL price	SYMBOL price	NOTES
				ZT26			given height over the desktop
				ZT28			given height over the desktop
<p>ADDITIONAL ELEMENTS</p> 	 <p>500x300x5</p>			ZT10			freestanding plexiglass panel
				ZF04			plexiglass reading shelf
				M02			2 x RJ45 3 x 230 V
				E60			

CITY	DIMENSIONS (mm) width x depth x height a / a' b / b' c / c'	SYMBOL price	SYMBOL price	SYMBOL price	NOTES
	1600	PLF02			batten for conference table
	1800	PLF03			batten for conference table
	140x70x750	S81			vertical cable duct in colour 09-aluminium
					
	<p data-bbox="153 1030 231 1064">TABLE</p>  <p data-bbox="153 1646 470 1680">STORAGES WITH HPL FRONT</p>	ø800, H=740	PLF80		
470x616x580		SLK13			include pencil tray
470x616x580		SLK12			include pencil tray, one filing drawer
470x616x580		SKP13			pillow for SLK12, SLK13
802x432x1833		A5404H			
802x432x1833		A5104H			
802x432x1129		A3404H			

CITY	DIMENSIONS (mm) width x depth x height a / a' b / b' c / c'			SYMBOL price	SYMBOL price	SYMBOL price	NOTES
<p>STORAGES WITH HPL FRONT AND GLASS TOP</p>          	802x432x1129	A3104H					
	802x432x777	A2104H					
	802x432x777	A3504G					
	802x432x1129	A3404HG					
	802x432x1129	A3104HG					
	802x432x777	A2504G					
	802x432x777	A2104HG					
	802x432x33	A800GT			MFC + glass		
	<p>SLIDING DOORS STORAGES</p>   	2000x434x1129	ZS02			front: HPL	
		2000x434x1129	ZS03			front: HPL	
428x385x403		ZSZ01			drawer for ZS02, ZS03		
 <p>These storages do not have locks Ohne Verschluss im Standard Armoires ne sont pas équipées d'une serrure</p>							