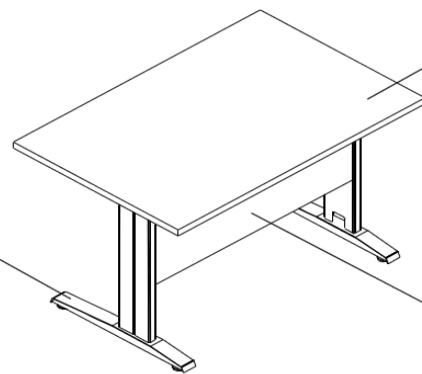

TECHNICAL SPECIFICATION / TECHNISCHE BESCHREIBUNG / DESCRIPTION TECHNIQUE

ogi_n

**Frame
Gestell
Piétement**

metal frame with cable management in the column, colour 09-aluminium
Metall pulverbeschichtet, Farbe 09-Aluminium
piétement métallique en L, électrification verticale (pieds), couleur 09-aluminium

**Top
Schreibtischplatte
Plan**

MFC / Melaminplatte /
Panneau mélaminé
28mm

**Modesty panel
Knieblende
Voiles de fond structurel**

MFC / Melaminplatte /
Panneau mélaminé
18mm

ogi_u

10mm spacers between the top and the frame
Distanz 10mm zwischen der Schreibtischplatte
und dem Gestell
la distance de 10mm entre le plan
et le piétement

**Frame
Gestell
Piétement**

profile 30x60mm, colour 09-aluminium
Metallprofil 30x60mm,
pulverbeschichtet, Farbe 09-Aluminium
piétement arche 30x60mm, couleur 09-aluminium,
pieds raccordes avec une poutre

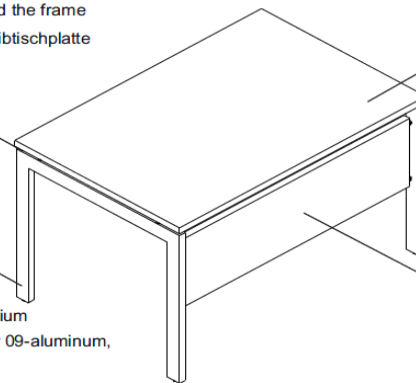
**Top
Schreibtischplatte
Plan**

MFC / Melaminplatte /
Panneau mélaminé
28mm

**Modesty panel
Knieblende
Voiles de fond structurel**

MFC / Melaminplatte /
Panneau mélaminé
18mm

ogi_y

**Frame
Gestell
Piétement**

profile 40x40mm, colour 09-aluminium, legs connected with lateral profile
Metallprofil 40x40mm, pulverbeschichtet, Farbe 09-Aluminium, Füße mit einem Querbalken
piétement quatre pieds en profil 40x40mm, couleur 09-aluminium, pieds raccordes avec une poutre

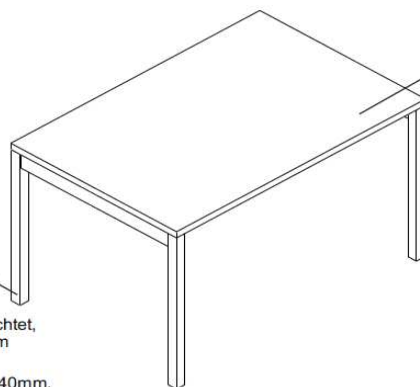
**Top
Schreibtischplatte
Plan**

MFC / Melaminplatte /
Panneau mélaminé
28mm

**Top
Schreibtischplatte
Plan**

MFC / Melaminplatte /
Panneau mélaminé
28mm

**Modesty panel
Knieblende
Voiles de fond structurel**

MFC / Melaminplatte /
Panneau mélaminé
18mm

ogi_v

**Frame
Gestell
Piétement**

panel ends made of 28mm MFC
Füße - Melaminplatte 28mm
piétement mélaminé ép. 28mm

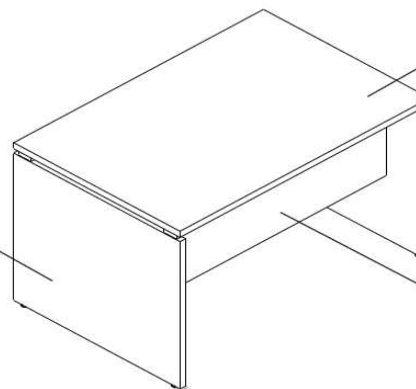

TECHNICAL SPECIFICATION / TECHNISCHE BESCHREIBUNG / DESCRIPTION TECHNIQUE

MANAGER DESK / MANAGERSCHREIBTISCHE / BUREAU DE MANAGER

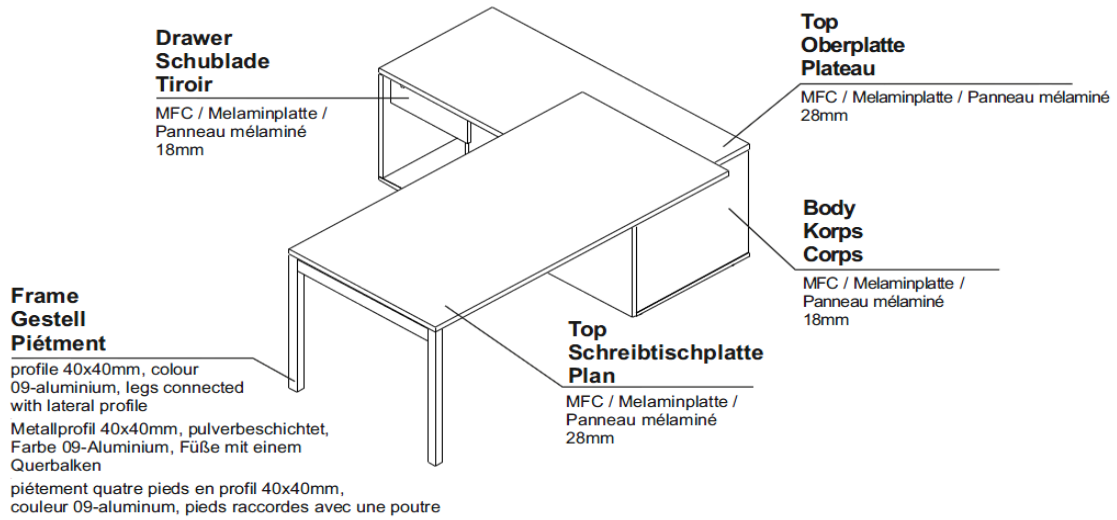

PARTITION WALLS AND PINBOARDS FOR SCREENS / TRENWÄND - MELAMINPLATTE UND STOFFPANEL / CLOISONS MELAMINE EN CLOISONS TISSUS

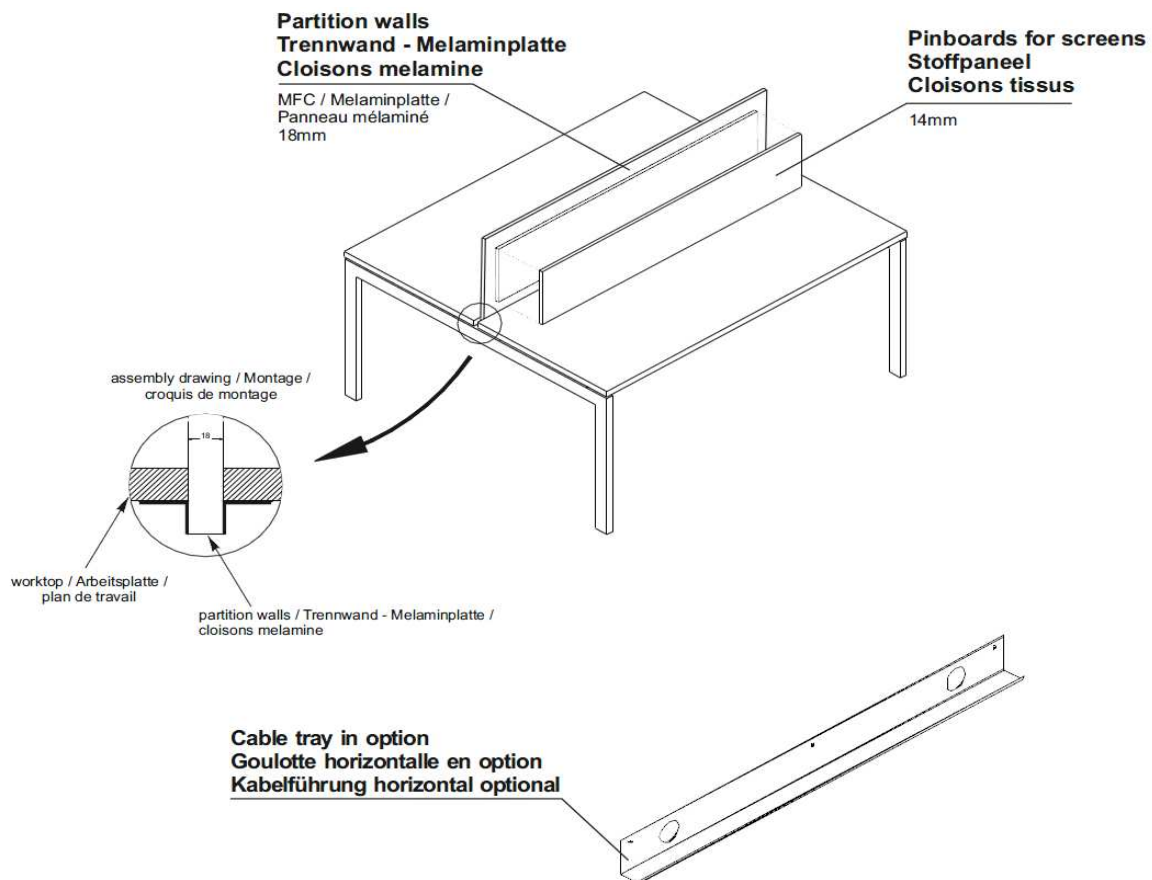

TECHNICAL SPECIFICATION / TECHNISCHE BESCHREIBUNG / DESCRIPTION TECHNIQUE



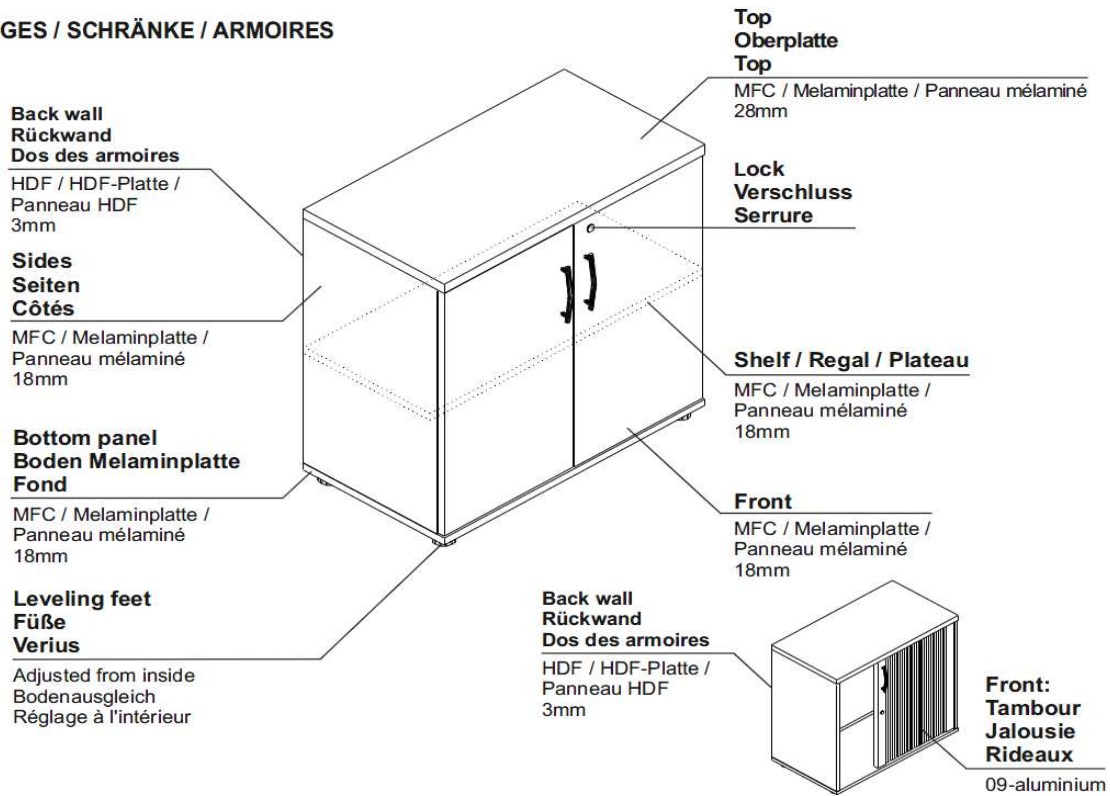



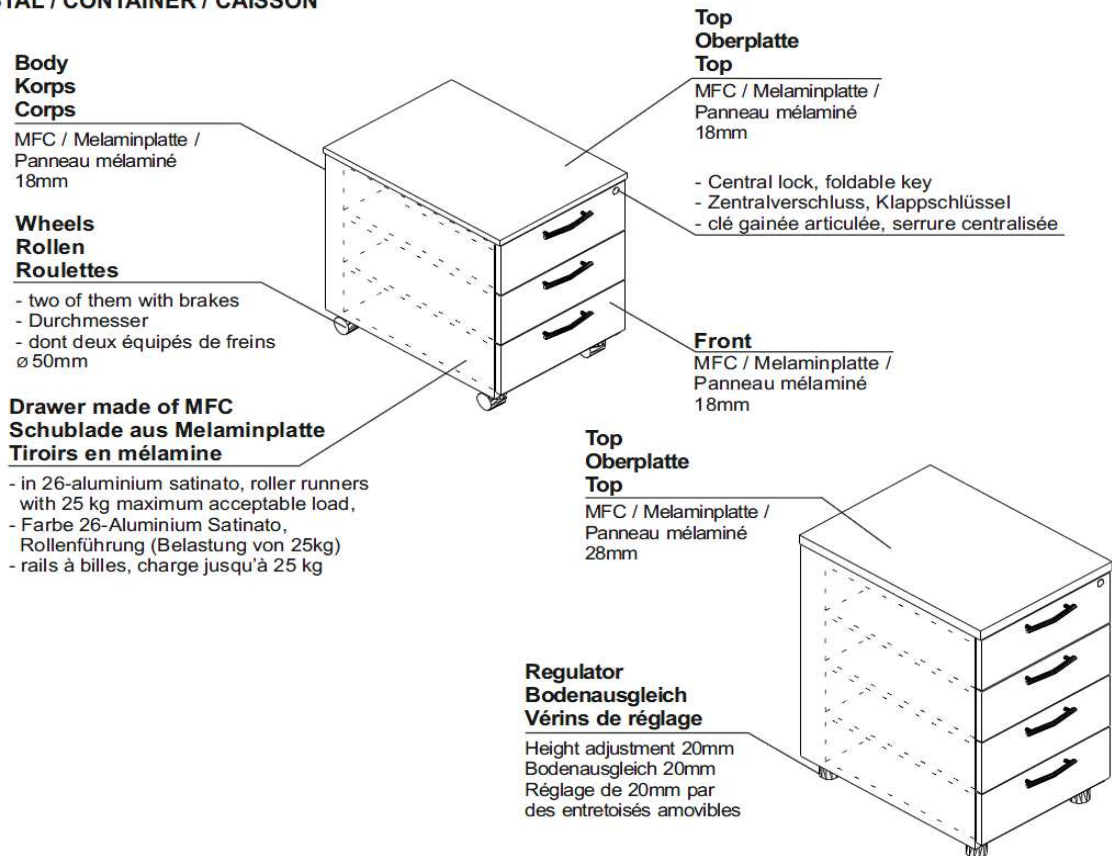



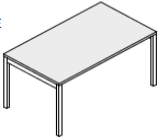

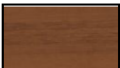

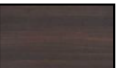
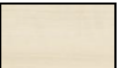
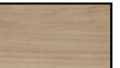
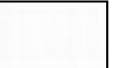
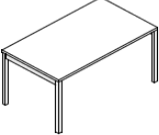
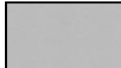

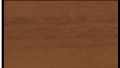
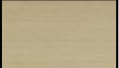





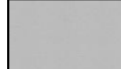
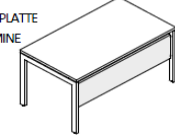

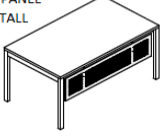

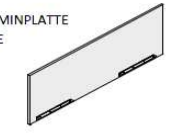

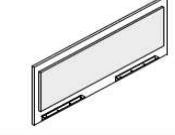





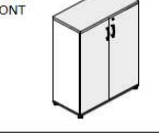



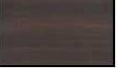
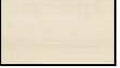

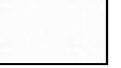
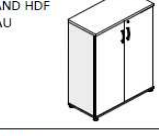
STORAGES / SCHRÄNKE / ARMOIRES

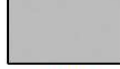







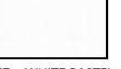



PEDESTAL / CONTAINER / CAISSON

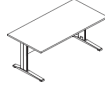
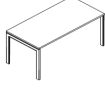
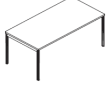

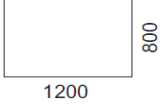
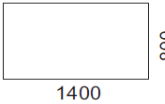
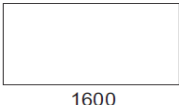
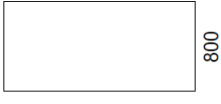
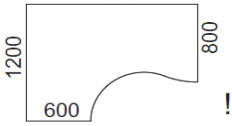
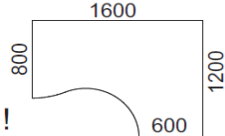
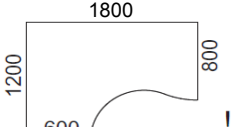
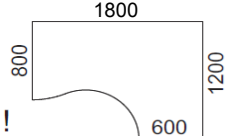
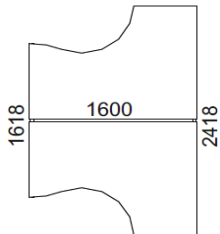



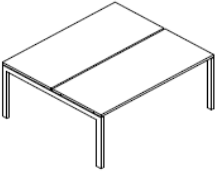
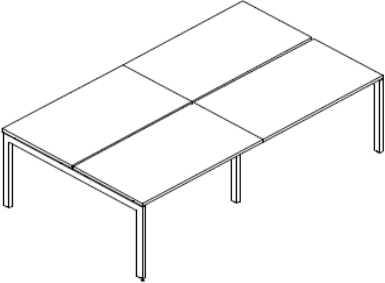
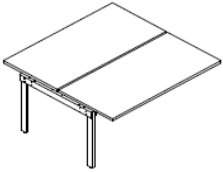

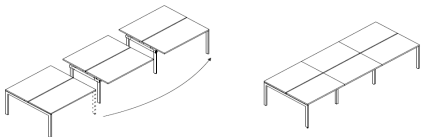

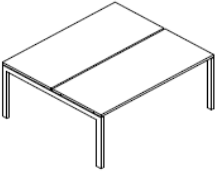
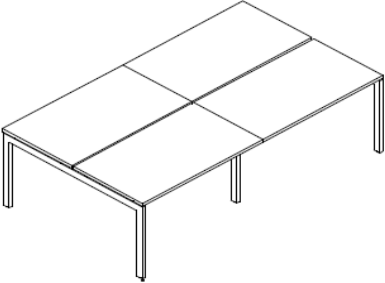
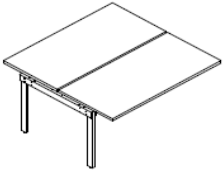

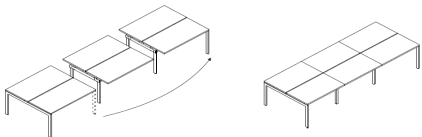
FINISHES / FARBEN / FINITIONS

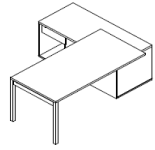
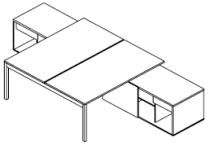

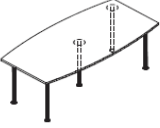
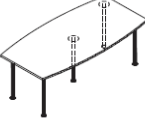



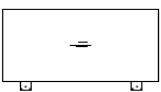

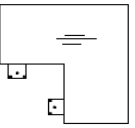
<p>TOP SCHREIBTISCHPLATTE PLAN DE TRAVAIL</p> 	 14 – BEECH BUCHE HETRE	 23 – NUT NUßBAUM NOYER	 31 – CANADIAN OAK KANADISCHE EICHE CHENE CANADIAN	 34 – CHESTNUT WENGE WENGE	 39 – POLAR BIRCH POLARBIRKE BOULEAU CLAIR	 64 – COCOA COCOA COCOA	 67 – WHITE PASTEL WEIß PASTELL BLANC PASTEL	
<p>FRAME GESTELL PIEITEMENT</p> 	 09 – ALUMINIUM ALUMINIUM ALUMINIUM							
<p>EXTENSION ANSATZTISCH EXTENSION</p> 	 14 – BEECH BUCHE HETRE	 23 – NUT NUßBAUM NOYER	 31 – CANADIAN OAK KANADISCHE EICHE CHENE CANADIAN	 34 – CHESTNUT WENGE WENGE	 39 – POLAR BIRCH POLARBIRKE BOULEAU CLAIR	 64 – COCOA COCOA COCOA	 67 – WHITE PASTEL WEIß PASTELL BLANC PASTEL	
<p>SUPPORTING LEG STUTZFUß PIED DE SUPPORT</p> 	 09 – ALUMINIUM ALUMINIUM ALUMINIUM							
<p>MODESTY PANEL (MFC) KNEIBLENDE - MELAMINPLATTE VOILES DE FOND MELAMINE</p> 	 26 – ALUMINIUM SATINATO ALUMINIUM SATINATO ALUMINIUM SATINE	<p>METAL MODESTY PANEL KNEIBLENDE - METALL VOILES DE FOND EN METAL</p> 			 09 – ALUMINIUM ALUMINIUM ALUMINIUM			
<p>PARTITION WALLS TRENWANDE - MELAMINPLATTE CLOISONS MELAMINE</p> 	 26 – ALUMINIUM SATINATO ALUMINIUM SATINATO ALUMINIUM SATINE							
<p>PINBOARDS STOFFPANELE CLOISONS TISSUS</p> 	 NX2 – BEIGE BEIGE BEIGE	 NX3 – ORANGE ORANGE ORANGE	 NX5 – RED ROT ROUGE	 NX9 – GREEN GRÜN VERT	 NX10 – GRAY GRAU GRIS	 NX15 – NAVY BLUE DUNKELBLAU BLEU MARIN		
<p>COUNTER TOP AND FRONT OBERPLATTE UND FRONT TOP ET FRONT</p> 	 14 – BEECH BUCHE HETRE	 23 – NUT NUßBAUM NOYER	 31 – CANADIAN OAK KANADISCHE EICHE CHENE CANADIAN	 34 – CHESTNUT WENGE WENGE	 39 – POLAR BIRCH POLARBIRKE BOULEAU CLAIR	 64 – COCOA COCOA COCOA	 67 – WHITE PASTEL WEIß PASTELL BLANC PASTEL	
<p>BODY AND BACK WALL HDF KORPS UND RÜCKWAND HDF CORPS ET LA PANNEAU ARRIERE HDF</p> 	 26 – ALUMINIUM SATINATO ALUMINIUM SATINATO ALUMINIUM SATINE			<p>BODY KORPS CORPS</p> 		 26 – ALUMINIUM SATINATO ALUMINIUM SATINATO ALUMINIUM SATINE		
<p>COUNTER TOP AND FRONT OBERPLATTE UND FRONT TOP ET FRONT</p> 	 14 – BEECH BUCHE HETRE	 23 – NUT NUßBAUM NOYER	 31 – CANADIAN OAK KANADISCHE EICHE CHENE CANADIAN	 34 – CHESTNUT WENGE WENGE	 39 – POLAR BIRCH POLARBIRKE BOULEAU CLAIR	 64 – COCOA COCOA COCOA	 67 – WHITE PASTEL WEIß PASTELL BLANC PASTEL	

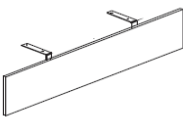
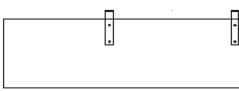
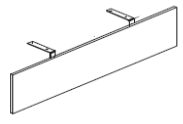
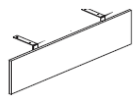
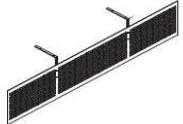

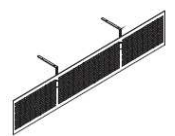
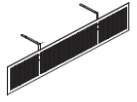

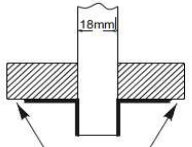





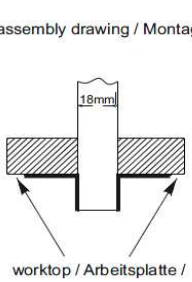
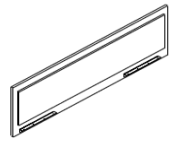
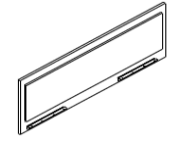
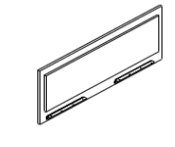
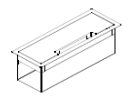

OGI	DIMENSIONS (mm) width x depth x height a / a' b / b' c / c'	SYMBOL price 	SYMBOL price 	SYMBOL price 	SYMBOL price 
STRAIGHT / RADIAL DESKS					
	1200x800x720	BN02	BU02	BU02	BV02
	1400x800x720	BN03	BU03	BY03	BV03
	1600x800x720	BN04	BU04	BY04	BV04
	1800x800x720	BN05	BU05	BY05	BV05
	1600x1200x720	BN10	BU10	BY10	BV10
	1600x1200x720	BN11	BU11	BY11	BV11
	1800x1200x720	BN17	BU17	BY17	BV17
	1800x1200x720	BN18	BU18	BY18	BV18
			BU15	BY15	
<p>! Attention: The use of supporting leg NK41 is required with radial desks B..10, B..11 and B...15.</p> 	690	NK41			





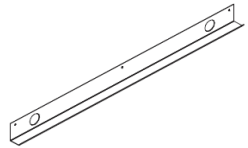
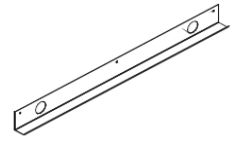
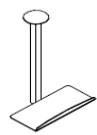

OGI	DIMENSIONS (mm) width x depth x height a / a' b / b' c / c'	SYMBOL price	SYMBOL price	SYMBOL price	NOTES
<p>SETS OF DESKS TYPE "BU"</p> 	1200x1618x720	BU32			
	1400x1618x720	BU33			
	1600x1618x720	BU34			
	2400x1618x720	BU54			BU32, BU12
	2600x1618x720	BU55			BU32, BU13
	2800x1618x720	BU56			BU33, BU13
	3000x1618x720	BU57			BU33, BU14
	3200x1618x720	BU58			BU34, BU14
	1200x1618x720	BU12			element for the sets of desks
	1400x1618x720	BU13			element for the sets of desks
<p>STAGES IN THE ARRANGEMENT OF DESKS TYPE „BU“</p> <p>STAGE I - choose the corresponding amount of elements necessary for the arrangement of the system</p>  <p>STAGE II - assembly working station construction</p> 	1600x1618x720	BU14			element for the sets of desks



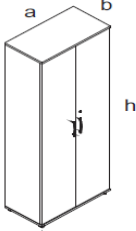
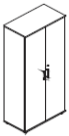
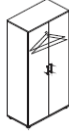
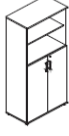
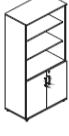
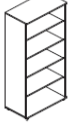
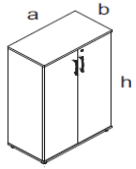
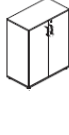

OGI	DIMENSIONS (mm) width x depth x height a / a' b / b' c / c'	SYMBOL price	SYMBOL price	SYMBOL price	NOTES
<p>SETS OF DESKS TYPE "BY"</p> 	1200x1618x720	BY32			
	1400x1618x720	BY33			
	1600x1618x720	BY34			
	2400x1618x720	BY54			BY32, BY12
	2600x1618x720	BY55			BY32, BY13
	2800x1618x720	BY56			BY33, BY13
	3000x1618x720	BY57			BY33, BY14
	3200x1618x720	BY58			BY34, BY14
	1200x1618x720	BY12			element for the sets of desks
	1400x1618x720	BY13			element for the sets of desks
<p>STAGES IN THE ARRANGEMENT OF DESKS TYPE</p> <p>STAGE I - choose the corresponding amount of elements necessary for the arrangement of the system</p>  <p>STAGE II - assembly working station construction</p> 	1600x1618x720	BY14			element for the sets of desks

OGI	DIMENSIONS (mm) width x depth x height a / a' b / b' c / c'	SYMBOL price	SYMBOL price	SYMBOL price	NOTES
MANAGER DESK 	1600x1600x720	BY20			
TABLES "PO" 	1600x1618x720	BY40			
	640xpriem.550	PS2			glass top, frame color: 09- aluminum
	2400x1000x720	PO52			
	2000x1000x720	PO41			
	1600x750x725	PSU06			folding table, legs in chrome colour
EXTENSIONS AND CONNECTORS 	600x800	PK02			supporting leg (1 pcs) not included in the price
	1000x600	PK11			supporting leg (1 pcs) not included in the price
	1200x600	PK12			supporting legs (2 pcs) not included in the price
	1600x600	PK16			supporting legs (2 pcs) not included in the price
 supporting leg not included in the price	800x800	PK40			supporting leg (1 pcs) not included in the price
	600x600	PK27			supporting leg (1 pcs) not included in the price

OGI		DIMENSIONS (mm) width x depth x height a / a' b / b' c / c'	SYMBOL price	SYMBOL price	SYMBOL price	NOTES
SUPPORTING LEG			690	NK41		
MODESTY PANELS (MFC)			1600x18x400	UK5		panel for desks „BU” and „BY” 1800mm wide
		1400x18x400	UK4			panel for desks „BU” and „BY” 1600mm wide
		1200x18x400	UK3			panel for desks „BU” and „BY” 1400mm wide
METAL MODESTY PANELS			1600x15x300	UK16		panel for desks „BU” and „BY” 1800mm wide
		1400x15x300	UK15			panel for desks „BU” and „BY” 1600mm wide
		1200x15x300	UK14			panel for desks „BU” and „BY” 1400mm wide
PARTITION WALLS			1700x18x384	RK17		given height over the desktop
assembly drawing / Montage /		1500x18x384	RK15			given height over the desktop
		1300x18x384	RK13			given height over the desktop
worktop / Arbeitsplatte /		1100x18x384	RK11			given height over the desktop
PARTITION WALLS WITH PINBOARDS			1700x18x384	RK17		given height over the desktop pinboard mounted on both sides

OGI		DIMENSIONS (mm)			SYMBOL price	SYMBOL price	SYMBOL price	NOTES
		width x depth x height a / a' b / b' c / c'						
assembly drawing / Montage /  worktop / Arbeitsplatte /		1500x18x384	RK15				given height over the desktop pinboard mounted on both sides	
		1300x18x384	RK13				given height over the desktop pinboard mounted on both sides	
		1100x18x384	RK11				given height over the desktop pinboard mounted on both sides	
			M01				4 x 230V 2 x RJ45 class E, cat.6	
		priem. 80 mm	PK80				cable port Ø 80 mm	
ACCESSOIRES								
CONFIGURATION MEDIATEX / KONFIGURATION MEDIATEX / CONFIGURATION MEDIATEX STRAIGHT DESK GERADESCHREIBTISCHE BUREAUX DROITS  RADIAL DESK FORMSCHREIBTISCHE BUREAUX COMPACTS 								
CONFIGURATION CABLE PORT / KABELDURCHLASS / CONFIGURATION PASSE-CABLES STRAIGHT DESK GERADESCHREIBTISCHE BUREAUX DROITS   RADIAL DESK FORMSCHREIBTISCHE BUREAUX COMPACTS  								
STRAIGHT DESK GERADESCHREIBTISCHE BUREAUX DROITS  RADIAL DESK FORMSCHREIBTISCHE BUREAUX COMPACTS 								
		140x70x750	S81				vertical cable duct, 09-aluminium	
		1386x64x100	EG16				metal cable trays for desk's sets "BU", "BY"	
		1186x64x100	EG14				metal cable trays for desk's sets "BU", "BY"	
		460x617	S83				computer hanger	
		220x470x148	S73				computer stand (on wheels)	

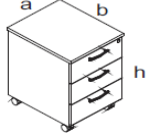
OGI		DIMENSIONS (mm)			SYMBOL price	SYMBOL price	SYMBOL price	NOTES
		width x depth x height a / a' b / b' c / c'						
<p>STORAGES AND BOOKCASES 5 OH</p> 		802x385x1833	K5104					
		802x385x1833	K5204				wardrobe with slide - out hanger	
		802x385x1833	K5304					
		802x385x1833	K5404					
		802x385x1833	K5504					
	<p>STORAGES AND BOOKCASES 3 OH</p> 		802x385x1129	K3104				
		802x385x1129	K3404					
		802x385x1129	K3504					
<p>STORAGES AND BOOKCASES 2 OH</p>		802x385x777	K2104					
		802x385x777	K2504					
<p>STORAGES HANGING UNITS 2OH</p>		802x385x750	K1104					
		802x385x750	K1504					

OGI		DIMENSIONS (mm)	SYMBOL price	SYMBOL price	SYMBOL price	NOTES
		width x depth x height a / a' b / b' c / c'				
TAMBOUR CUPBOARD		1200x385x1127	K3Z06			
CABINET FOR PHOTOCOPIER		710x600x600	S85			
PEDESTALS		434x520x580	KK13			
		434x600x720	KK64			
		434x800x720	KK74			